

The GH-Method

Viscoelastic Glucose Theory (VGT #10): Applying Elasticity Theory, Viscoelasticity Theory, and Energy Theory to Conduct a Comparison Study Between the Author's Collected 101,595 Postprandial Plasma Glucose (PPG) Data and Synthesized Waveform During the Past 6.5 Years and Two Hypothetical Cases of PPG Data and Waveforms to Illustrate Viscoelastic PPG Behavior and Associated Relative Energy of PPG Based on GH-Method: Math-Physical Medicine (No. 589)

Gerald C. Hsu*

eclairMD Foundation, USA

Note: Readers who want to get a quick overview can read the abstract, results, and graphs.

Abstract

The author utilized a continuous glucose monitoring (CGM) sensor device to collect 96 glucoses daily along with 13 postprandial plasma glucose (PPG) data for each meal. To date, he has collected 7,815 meals PPG values (a total of 101,595 data) with an average carbs/sugar intake amount of 14.1 grams and an average post-meal walking of 4.325 k-steps. Recently, he has applied viscoelastic and viscoplastic glucose theory (VGT) to conduct his research on various biomarkers behaviors since almost all known biomarkers are time-dependent variables. Initially, he completed the PPG behavior analyses using 3 known methods: time-domain (TD), space-domain (SD), and frequency-domain (FD). They are used to study the PPG wave characteristics, viscoelastic stress-strain relationship, and PPG's associated energy from TD and FD. Out of curiosity regarding the applicability of research findings of using his PPG data, he decided to construct two hypothetical cases. The first case was to construct one PPG waveform based on linear elastic glucose theory (LEGT) which is named as the "triangle case" due to its PPG waveform shape. The second case was to construct another PPG waveform which climbed from 0-minute to 60-minutes before remaining flat after 60-minutes; therefore, it is named as the "flat case" due to its PPG waveform shape after 60-minutes. Once the two PPG curves were constructed in TD, he followed the same procedures to build their respective spatial-diagram of stress-strain relationship for the viscoelastic validation and FD using fast Fourier Transform (FFT) for energy estimation. In the

stress-strain analysis, he has selected the PPG value as the strain (ϵ) and the PPG change rate, or the strain rate ($d\epsilon/dt$), multiplied with his average carbs/sugar grams, which is the viscosity factor (η), as his respective stress (σ), in order to construct three separate stress-strain diagrams. The following defined equations are used to establish the stress-strain diagram: Strain = ϵ = individual PPG value at present time. Stress = $\sigma = \eta * (d\epsilon/dt) = \eta * (d\text{-strain}/d\text{-time}) = (\text{viscosity factor } \eta \text{ using averaged carbs/sugar intake amount of } 14.1 \text{ grams for all of these 3 selected cases}) * (\text{PPG at present time} - \text{PPG at previous time}) / 15$, where 15 indicates the 15-minute timespan of his collected PPG data. He also applied the FFT operation to convert his PPG waveform from a TD into a FD, where he calculated the associated energy of PPG in TD and FD using the following two equations: Energy in time-domain (TD) = Summation of squares for each sample (each glucose component on the Y-axis of TD). Energy in frequency-domain (FD) = Summation of squares for each sample (each Y-axis value of FD corresponding to each frequency component on the X-axis of FD) and then divided by the total number of samples (total number-counts on the X-axis of FD). After completing the above-described steps, he generated the following useful information: (1) An organized raw data table containing PPG at each 15-minute time instant, average carbs/sugar grams (viscosity factor, η), and average post-meal walking k-steps. (2) A detailed TD PPG data and waveform for each case. (3) Three constructed stress-strain diagrams for the three cases. (4) A set of calculated TD and FD energies associated with

Received: 09 February 2022, Accepted: 03 March 2022, Available online: 10 March 2022

*Corresponding author: Gerald C. Hsu, eclairMD Foundation, USA

the three cases. To offer a simple explanation to readers who do not have a physics or engineering background, the author includes a brief excerpt from Wikipedia regarding the description of basic concepts for elasticity and plasticity theories, viscoelasticity and viscoplasticity theories from the disciplines of engineering and physics in the method section. In summary, the following four observations outline the findings from this research work: (1) From TD waveforms, the three cases have identical average PPG values by design. However, their waveforms are different due to their different strain values i.e., PPG values, at each time instant which further contributes to the different strain rate or PPG change rate, which provides varying stress values. (2) From the stress-strain diagrams, all three diagrams appear differently in regard to their grand views. Although they are similar in their main characteristics, where the 3 stress-strain diagrams present viscoelastic behaviors with different sized hysteresis loops, when looking into their details more carefully, the 6.5-year stress-strain diagram (σ - ϵ diagram) has smoother curves to enclose its hysteresis loop since their stress-strain values come from the author's real measured PPG data. The hypothetical triangle and flat cases have straight-line segments in their respective TD diagrams. Therefore, after calculating their stresses using a straight-line's linear strain rates multiplied with a constant

viscosity factor (η) with an average carbs/sugar amount of 14.1 grams, the respective stress-strain diagram becomes simplified, not as complicated as the real data case covering 6.5 years. (3) The PPG associated energy can be obtained using the energy equation from TD and FD, separately. Since the author manufactured the triangle and flat cases with identical average PPG values as with the case covering 6.5-years. The TD energy's for the three cases are identical as well. However, the FD energy's calculations show different results for the three cases: 243 for the case over 6.5-years, 70 for the triangle case, 25 for the flat case. If using the flat case as the base of 100%, then the triangle case's energy is 300% and the case over 6.5-years is 1000%. This observation indicates that the energy is not only related to the wave's average value, but is also influenced by the wave's peak value and wave fluctuation or strain rate. (4) All of the above illustrations indicate a conclusion that the author's elastic PPG waves in TD are actually viscoelastic, which is time-dependent in the stress-strain diagram. The triangle case is generated using the LEGT method which is useful and a simplified model for the predicted PPG values. However, the flat case is a purely hypothetical case which is difficult to achieve in real life for diabetes patients since their PPG values normally fluctuate over time and is difficult to remain as a flat line.

Keywords: Viscoelastic glucose theory; Elasticity theory; Viscoelasticity theory; Energy theory; Postprandial plasma glucose

Abbreviations: PPG: postprandial plasma glucose; MPM: math-physical medicine; FPG: fasting plasma glucose; CGM: continuous glucose monitoring; TD: time-domain; FD: frequency-domain

1. INTRODUCTION

The author utilized a continuous glucose monitoring (CGM) sensor device to collect 96 glucoses daily along with 13 postprandial plasma glucose (PPG) data for each meal. To date, he has collected 7,815 meals PPG values (a total of 101,595 data) with an average carbs/sugar intake amount of 14.1 grams and an average post-meal walking of 4.325 k-steps. Recently, he has applied viscoelastic and viscoplastic glucose theory (VGT) to conduct his research on various biomarkers behaviors since almost all known biomarkers are time-dependent variables. Initially, he completed the PPG behavior analyses using 3 known methods: time-domain (TD), space-domain (SD), and frequency-domain (FD). They are used to study the PPG wave characteristics, viscoelastic stress-strain relationship, and PPG's associated energy from TD and FD. Out of curiosity regarding the applicability of research findings of using his PPG data, he decided to construct two hypothetical cases. The first case was to construct one PPG waveform based on linear elastic glucose theory (LEGT) which is named as the "triangle case" due to its PPG waveform shape. The second case was to construct another PPG waveform which climbed from 0-minute to 60-minutes before remaining flat after 60-minutes; therefore, it is named as the "flat case" due to its PPG waveform shape after 60-minutes. Once the two PPG curves were constructed in TD, he followed the same procedures to build their respective spatial-diagram of stress-strain relationship for the viscoelastic validation and FD using fast Fourier Transform (FFT) for energy estimation.

In the stress-strain analysis, he has selected the PPG value as the strain (ϵ) and the PPG change rate, or the strain rate ($d\epsilon/dt$), multiplied with his average carbs/sugar grams, which is the viscosity factor (η), as his respective stress (σ), in order to construct three separate stress-strain diagrams.

The following defined equations are used to establish the stress-strain diagram:

Strain
 $= \epsilon$
 $=$ individual PPG value at present time

Stress
 $= \sigma$
 $= \eta * (d\epsilon/dt)$
 $= \eta * (d\text{-strain}/d\text{-time})$
 $= (\text{viscosity factor } \eta \text{ using averaged carbs/sugar intake amount of 14.1 grams for all of these 3 selected cases}) * (\text{PPG at present time} - \text{PPG at previous time}) / 15$

Where 15 indicates the 15-minute timespan of his collected PPG data.

He also applied the FFT operation to convert his PPG waveform from a TD into a FD, where he calculated the associated energy of PPG in TD and FD using the following two equations:

Energy in time-domain (TD) = Summation of squares for each sample (each glucose component on the Y-axis of TD).

Energy in frequency-domain (FD) = Summation of squares for each sample (each Y-axis value of FD corresponding to each frequency component on the X-axis of FD) and then divided by the total number of samples (total number-counts on the X-axis of FD).

After completing the above-described steps, he generated the following useful information:

- (1) An organized raw data table containing PPG at each 15-minute time instant, average carbs/sugar grams (viscosity factor, η), and average post-meal walking k-steps.
- (2) A detailed TD PPG data and waveform for each case.
- (3) Three constructed stress-strain diagrams for the three cases.
- (4) A set of calculated TD and FD energies associated with the three cases.

To offer a simple explanation to readers who do not have a physics or engineering background, the author includes a brief excerpt from Wikipedia regarding the description of basic concepts for elasticity and plasticity theories, viscoelasticity and viscoplasticity theories from the disciplines of engineering and physics in the method section.

2. METHODS

2.1 Elasticity, plasticity, viscoelasticity and viscoplasticity

The difference between elastic materials and viscoelastic materials (from “Soborthans, innovating shock and vibration solutions”).

What are elastic materials?

Elasticity is the tendency of solid materials to return to their original shape after forces are applied on them. When the forces are removed, the object will return to its initial shape and size if the material is elastic.

What are viscous materials?

Viscosity is a measure of a fluid’s resistance to flow. A fluid with large viscosity resists motion. A fluid with low viscosity flows. For example, water flows more easily than syrup because it has a lower viscosity. High viscosity materials might include honey, syrups, or gels – generally things that resist flow. Water is a low viscosity material, as it flows readily. Viscous materials are thick or sticky or adhesive. Since heating reduces viscosity, these materials don't flow easily. For example, warm syrup flows more easily than cold.

What is viscoelastic?

Viscoelasticity is the property of materials that exhibit both viscous and elastic characteristics when undergoing deformation. Synthetic polymers, wood, and human tissue, as well as metals at high temperature, display significant viscoelastic effects. In some applications, even a small viscoelastic response can be significant.

Elastic behavior versus viscoelastic behavior

The difference between elastic materials and viscoelastic materials is that viscoelastic materials have a viscosity factor and the elastic ones don't. Because viscoelastic materials have the viscosity factor, they have a strain rate dependent on time. Purely elastic materials do not dissipate energy (heat) when a load is applied, then removed; however, a viscoelastic substance does.

The following brief introductions are excerpts from Wikipedia:

“Elasticity (physics):

Physical property when materials or objects return to original shape after deformation.

In physics and materials science, elasticity is the ability of a body to resist a distorting influence and to return to its original size and shape when that influence or force is removed. Solid objects will deform when adequate loads are applied to them; if the material is elastic, the object will return to its initial shape and size after removal. This is in contrast to plasticity, in which the object fails to do so and instead remains in its deformed state.

The physical reasons for elastic behavior can be quite different for different materials. In metals, the atomic lattice changes size and shape when forces are applied (energy is added to the system). When forces are removed, the lattice goes back to the original lower energy state. For rubbers and other polymers, elasticity is caused by the stretching of polymer chains when forces are applied.

Hooke's law states that the force required to deform elastic objects should be directly proportional to the distance of deformation, regardless of how large that distance becomes. This is known as perfect elasticity, in which a given object will return to its original shape no matter how strongly it is deformed. This is an ideal concept only; most materials which possess elasticity in practice remain purely elastic only up to very small deformations, after which plastic (permanent) deformation occurs.

In engineering, the elasticity of a material is quantified by the elastic modulus such as the Young's modulus, bulk modulus or shear modulus which measure the amount of stress needed to achieve a unit of strain; a higher modulus indicates that the material is harder to deform. The material's elastic limit or yield strength is the maximum stress that can arise before the onset of plastic deformation.

Plasticity (physics):

Deformation of a solid material undergoing non-reversible changes of shape in response to applied forces.

In physics and materials science, plasticity, also known as plastic deformation, is the ability of a solid material to undergo permanent deformation, a non-reversible change of shape in response to applied forces. For example, a solid piece of metal being bent or pounded into a new shape displays plasticity as permanent changes occur within the material itself. In engineering, the transition from elastic behavior to plastic behavior is known as yielding.

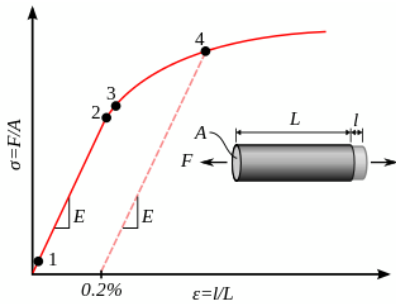

Stress–strain curve showing typical yield behavior for nonferrous alloys.

1. True elastic limit
2. Proportionality limit
3. Elastic limit
4. Offset yield strength

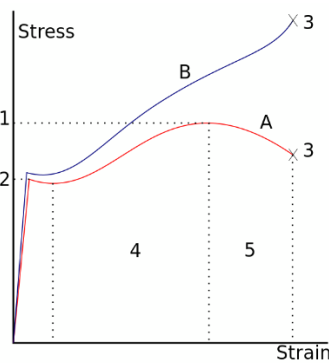

A stress–strain curve typical of structural steel.

- 1: Ultimate strength
- 2: Yield strength (yield point)
- 3: Rupture
- 4: Strain hardening region
- 5: Necking region
- A: Apparent stress (F/A_0)
- B: Actual stress (F/A)

Plastic deformation is observed in most materials, particularly metals, soils, rocks, concrete, and foams. However, the physical

mechanisms that cause plastic deformation can vary widely. At a crystalline scale, plasticity in metals is usually a consequence of dislocations. Such defects are relatively rare in most crystalline materials, but are numerous in some and part of their crystal structure; in such cases, plastic crystallinity can result. In brittle materials such as rock, concrete and bone, plasticity is caused predominantly by slip at microcracks. In cellular materials such as liquid foams or biological tissues, plasticity is mainly a consequence of bubble or cell rearrangements, notably T1 processes.

For many ductile metals, tensile loading applied to a sample will cause it to behave in an elastic manner. Each increment of load is accompanied by a proportional increment in extension. When the load is removed, the piece returns to its original size. However, once the load exceeds a threshold – the yield strength – the extension increases more rapidly than in the elastic region; now when the load is removed, some degree of extension will remain.

Elastic deformation, however, is an approximation and its quality depends on the time frame considered and loading speed. If, as indicated in the graph opposite, the deformation includes elastic deformation, it is also often referred to as "elasto-plastic deformation" or "elastic-plastic deformation".

Perfect plasticity is a property of materials to undergo irreversible deformation without any increase in stresses or loads. Plastic materials that have been hardened by prior deformation, such as cold forming, may need increasingly higher stresses to deform further. Generally, plastic deformation is also dependent on the deformation speed, i.e. higher stresses usually have to be applied to increase the rate of deformation. Such materials are said to deform viscoplastically.”

Viscoelasticity:

Property of materials with both viscous and elastic characteristics under deformation.

In materials science and continuum mechanics, viscoelasticity is the property of materials that exhibit both viscous and elastic characteristics when undergoing deformation. Viscous materials, like water,

resist shear flow and strain linearly with time when a stress is applied. Elastic materials strain when stretched and immediately return to their original state once the stress is removed.

Viscoelastic materials have elements of both of these properties and, as such, exhibit time-dependent strain. Whereas elasticity is usually the result of bond stretching along crystallographic planes in an ordered solid, viscosity is the result of the diffusion of atoms or molecules inside an amorphous material.

In the nineteenth century, physicists such as Maxwell, Boltzmann, and Kelvin researched and experimented with creep and recovery of glasses, metals, and rubbers. Viscoelasticity was further examined in the late twentieth century when synthetic polymers were engineered and used in a variety of applications. Viscoelasticity calculations depend heavily on the viscosity variable, η . The inverse of η is also known as fluidity, ϕ . The value of either can be derived as a function of temperature or as a given value (i.e. for a dashpot).

Depending on the change of strain rate versus stress inside a material, the viscosity can be categorized as having a linear, non-linear, or plastic response. When a material exhibits a linear response, it is categorized as a Newtonian material. In this case the stress is linearly proportional to the strain rate. If the material exhibits a non-linear response to the strain rate, it is categorized as non-Newtonian fluid. There is also an interesting case where the viscosity decreases as the shear/strain rate remains constant. A material which exhibits this type of behavior is known as thixotropic. In addition, when the stress is independent of this strain rate, the material exhibits plastic deformation. Many viscoelastic materials exhibit rubber-like behavior explained by the thermodynamic theory of polymer elasticity.

Cracking occurs when the strain is applied quickly and outside of the elastic limit. Ligaments and tendons are viscoelastic, so the extent of the potential damage to them depends both on the rate of the change of their length as well as on the force applied.

A viscoelastic material has the following properties:

- hysteresis is seen in the stress–strain curve
- stress relaxation occurs: step constant strain causes decreasing stress
- creep occurs: step constant stress causes increasing strain
- its stiffness depends on the strain rate or the stress rate.

Elastic versus viscoelastic behavior

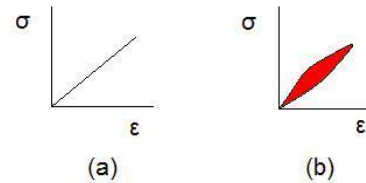

Stress–strain curves for a purely elastic material (a) and a viscoelastic material (b). The red area is a hysteresis loop and shows the amount of energy lost (as heat) in a loading and unloading cycle. It is equal to

$$\oint \sigma d\epsilon$$

where σ is stress and ϵ is strain.

Unlike purely elastic substances, a viscoelastic substance has an elastic component and a viscous component. The viscosity of a viscoelastic substance gives the substance a strain rate dependence on time. Purely elastic materials do not dissipate energy (heat) when a load is applied, then removed. However, a viscoelastic substance dissipates energy when a load is applied, then removed. Hysteresis is observed in the stress–strain curve, with the area of the loop being equal to the energy lost during the loading cycle. Since viscosity is the resistance to thermally activated plastic deformation, a viscous material will lose energy through a loading cycle. Plastic deformation results in lost energy, which is uncharacteristic of a purely elastic material's reaction to a loading cycle.

Specifically, viscoelasticity is a molecular rearrangement. When a stress is applied to a viscoelastic material such as a polymer, parts of the long polymer chain change positions. This movement or rearrangement is called “creep”. Polymers remain a solid material even when these parts of their chains are rearranging in order to accompany the stress, and as this occurs, it creates a back stress in

the material. When the back stress is the same magnitude as the applied stress, the material no longer creeps. When the original stress is taken away, the accumulated back stresses will cause the polymer to return to its original form. The material creeps, which gives the prefix visco-, and the material fully recovers, which gives the suffix -elasticity.

Viscoplasticity:

Viscoplasticity is a theory in continuum mechanics that describes the rate-dependent inelastic behavior of solids. Rate-dependence in this context means that the deformation of the material depends on the rate at which loads are applied. The inelastic behavior that is the subject of viscoplasticity is plastic deformation which means that the material undergoes unrecoverable deformations when a load level is reached. Rate-dependent plasticity is important for transient plasticity calculations. The main difference between rate-independent plastic and viscoplastic material models is that the latter exhibit not only permanent deformations after the application of loads but continue to undergo a creep flow as a function of time under the influence of the applied load.

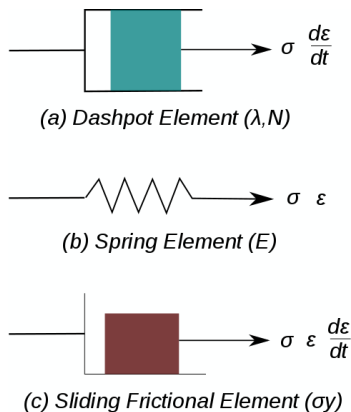

Figure 1. Elements used in one-dimensional models of viscoplastic materials.

The elastic response of viscoplastic materials can be represented in one-dimension by Hookean spring elements. Rate-dependence can be represented by nonlinear dashpot elements in a manner similar to viscoelasticity. Plasticity can be accounted for by adding sliding frictional elements as shown in Figure 1. In the figure E is the modulus of elasticity, λ is the viscosity parameter and N is a power-law type parameter that represents non-linear dashpot [$\sigma(d\epsilon/dt) = \sigma = \lambda(d\epsilon/dt)^{1/N}$]. The

sliding element can have a yield stress (σ_y) that is strain rate dependent, or even constant, as shown in Figure 1c.

Viscoplasticity is usually modeled in three-dimensions using overstress models of the Perzyna or Duvaut-Lions types. In these models, the stress is allowed to increase beyond the rate-independent yield surface upon application of a load and then allowed to relax back to the yield surface over time. The yield surface is usually assumed not to be rate-dependent in such models. An alternative approach is to add a strain rate dependence to the yield stress and use the techniques of rate independent plasticity to calculate the response of a material.

For metals and alloys, viscoplasticity is the macroscopic behavior caused by a mechanism linked to the movement of dislocations in grains, with superposed effects of inter-crystalline gliding. The mechanism usually becomes dominant at temperatures greater than approximately one third of the absolute melting temperature. However, certain alloys exhibit viscoplasticity at room temperature (300K). For polymers, wood, and bitumen, the theory of viscoplasticity is required to describe behavior beyond the limit of elasticity or viscoelasticity.

In general, viscoplasticity theories are useful in areas such as

- the calculation of permanent deformations,
- the prediction of the plastic collapse of structures,
- the investigation of stability,
- crash simulations,
- systems exposed to high temperatures such as turbines in engines, e.g. a power plant,
- dynamic problems and systems exposed to high strain rates.

Phenomenology

For a qualitative analysis, several characteristic tests are performed to describe the phenomenology of viscoplastic materials. Some examples of these tests are

1. hardening tests at constant stress or strain rate,
2. creep tests at constant force, and

- stress relaxation at constant elongation.

Strain hardening test

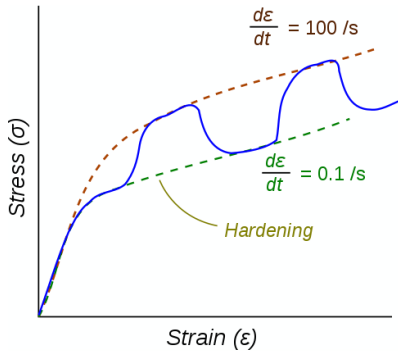

Figure 2. Stress–strain response of a viscoplastic material at different strain rates.

The dotted lines show the response if the strain-rate is held constant. The blue line shows the response when the strain rate is changed suddenly.

One consequence of yielding is that as plastic deformation proceeds, an increase in stress is required to produce additional strain. This phenomenon is known as Strain/Work hardening. For a viscoplastic material the hardening curves are not significantly different from those of rate-independent plastic material. Nevertheless, three essential differences can be observed.

- At the same strain, the higher the rate of strain the higher the stress.
- A change in the rate of strain during the test results in an immediate change in the stress–strain curve.
- The concept of a plastic yield limit is no longer strictly applicable.

The hypothesis of partitioning the strains by decoupling the elastic and plastic parts is still applicable where the strains are small, i.e.,

$$\epsilon = \epsilon_e + \epsilon_{vp}$$

where ϵ_e is the elastic strain and ϵ_{vp} is the viscoplastic strain.

To obtain the stress–strain behavior shown in blue in the figure, the material is initially loaded at a strain rate of 0.1/s. The strain rate is then instantaneously raised to 100/s and held constant at that value for some time. At the end of that time period the strain rate is dropped instantaneously back to 0.1/s and the cycle is continued for increasing values of

strain. There is clearly a lag between the strain-rate change and the stress response. This lag is modeled quite accurately by overstress models (such as the Perzyna model) but not by models of rate-independent plasticity that have a rate-dependent yield stress.”

3. RESULTS

Figure 1 displays the time-domain PPG waveforms of three cases (upper diagram) and the data table of both input data and calculation results (lower diagram).

Figure 2 shows the results of three stress-strain diagrams from viscoelastic study for these three cases. All of these 3 stress-strain diagrams have demonstrated viscoelastic behavior.

Figure 3 assembles background key data (top diagram), 3 time-domain waveforms (middle diagram), and 3 FD curves after using FFT operations (lower diagram). The calculated associated energy levels of PPG are also shown in the FD diagram.

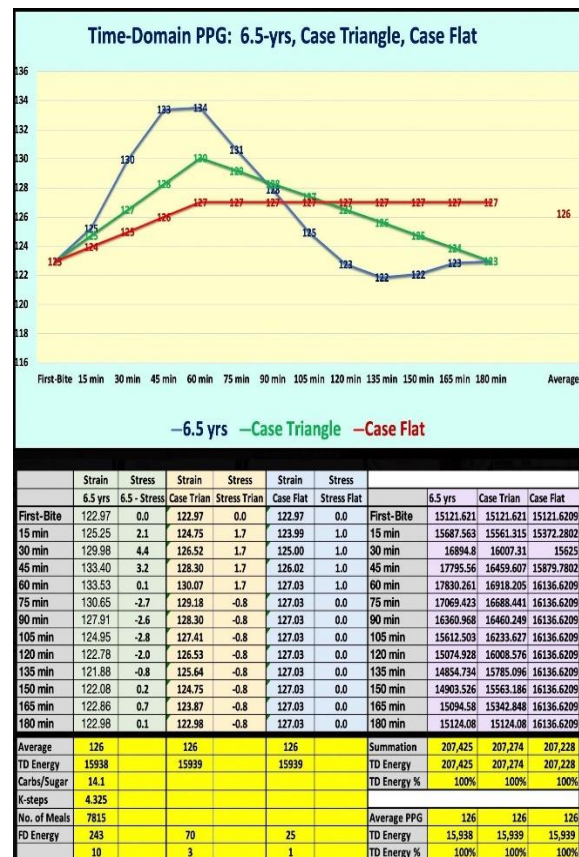

Figure 1: Time-domain diagram (upper diagram) and data table of both input data and calculation results (lower diagram) for 3 cases.

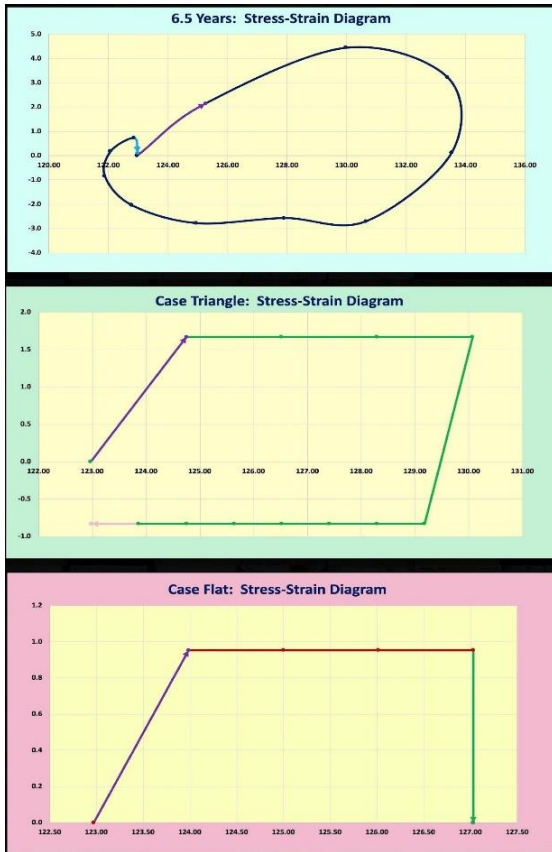

Figure 2: Viscoelastic stress-strain diagram for three cases.



Figure 3: Background key data (upper diagram). Time-domain PPG waveforms (middle diagram) and frequency-domain diagram of three cases.

4. CONCLUSION

In summary, the following four observations outline the findings from this research work:

(1) From TD waveforms, the three cases have identical average PPG values by design. However, their waveforms are different due to their different strain values i.e., PPG values, at each time instant which further contributes to the different strain rate or PPG change rate, which provides varying stress values.

(2) From the stress-strain diagrams, all three diagrams appear differently in regard to their grand views. Although they are similar in their main characteristics, where the 3 stress-strain diagrams present viscoelastic behaviors with different sized hysteresis loops, when looking into their details more carefully, the 6.5-year stress-strain diagram (σ - ϵ diagram) has smoother curves to enclose its hysteresis loop since their stress-strain values come from the author's real measured PPG data. The hypothetical triangle and flat cases have straight-line segments in their respective TD diagrams. Therefore, after calculating their stresses using a straight-line's linear strain rates multiplied with a constant viscosity factor (η) with an average carbs/sugar amount of 14.1 grams, the respective stress-strain diagram becomes simplified, not as complicated as the real data case covering 6.5 years.

(3) The PPG associated energy can be obtained using the energy equation from TD and FD, separately. Since the author manufactured the triangle and flat cases with identical average PPG values as with the case covering 6.5-years. The TD energy's for the three cases are identical as well. However, the FD energy's calculations show different results for the three cases: 243 for the case over 6.5-years, 70 for the triangle case, 25 for the flat case. If using the flat case as the base of 100%, then the triangle case's energy is 300% and the case over 6.5-years is 1000%. This observation indicates that the energy is not only related to the wave's average value, but is also influenced by the wave's peak value and wave fluctuation or strain rate.

(4) All of the above illustrations indicate a conclusion that the author's elastic PPG waves in TD are actually viscoelastic, which is time-dependent in the stress-strain diagram. The triangle case is generated using the LEGT method which is useful and a simplified model for the predicted PPG values. However, the flat case is a purely hypothetical case which is difficult to achieve

in real life for diabetes patients since their PPG values normally fluctuate over time and is difficult to remain as a flat line.

5. REFERENCES

For editing purposes, the majority of the references in this paper, which are self-references, have been removed. Only

references from other authors' published sources remain. The bibliography of the author's original self-references can be viewed at www.eclairemd.com.

Readers may use this article as long as the work is properly cited, and their use is educational and not for profit, and the author's original work is not altered.